

CM6310

EMI Filter with ESD Protection for SIM Card Applications

Product Description

The CM6310 is a 24-bump EMI filter with ESD protection device for data line application in a 0.5 mm pitch, 5 x 5 CSP form factor. It is fully compliant with IEC 61000-4-2. The CM6310 is RoHS II compliant.

Features

- 24-Bump, 2.60 mm X 2.60 mm Footprint Chip Scale Package
- These Devices are Pb-Free and are RoHS Compliant



ON Semiconductor®

<http://onsemi.com>

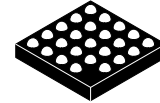

WLCSP24
CASE 567CJ

ELECTRICAL SCHEMATIC

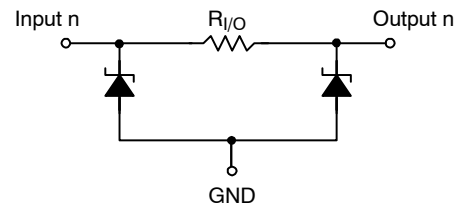

1 of 10 Filter Channels

MARKING DIAGRAM

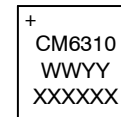

CM6310 = CM6310
WWYY = Date Code
XXXXXX = Last six digits of lot#

ORDERING INFORMATION

Device	Package	Shipping†
CM6310	CSP-24 (Pb-Free)	5000/Tape & Reel

†For information on tape and reel specifications, including part orientation and tape sizes, please refer to our Tape and Reel Packaging Specification Brochure, BRD8011/D.

CM6310

PACKAGE / PINOUT DIAGRAMS

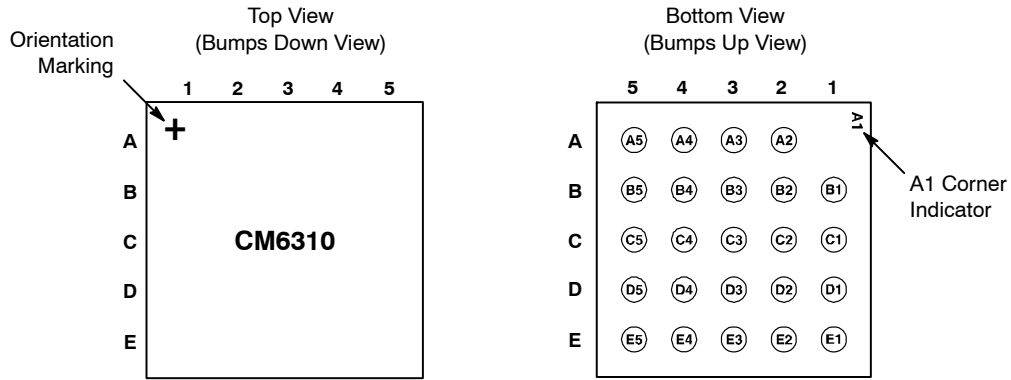

Table 1. PIN DESCRIPTIONS

Pin	Description	Pin	Description
B1	Channel 1 Input	D1	Channel 1 Output
C1	Channel 2 Input	E1	Channel 2 Output
A2	Channel 3 Input	D2	Channel 3 Output
C2	Channel 4 Input	E2	Channel 4 Output
B2	Channel 5 Input	D3	Channel 5 Output
C3	Channel 6 Input	E3	Channel 6 Output
A5	Channel 7 Input	D4	Channel 7 Output
C4	Channel 8 Input	E4	Channel 8 Output
B5	Channel 9 Input	D5	Channel 9 Output
C5	Channel 10 Input	E5	Channel 10 Output
A3	GND	B3	GND
A4	GND	B4	GND

ELECTRICAL SPECIFICATIONS AND CONDITIONS

Table 2. PARAMETERS AND OPERATING CONDITIONS

Parameter	Rating	Units
Storage Temperature Range	-55 to +150	°C
Operating Temperature Range	-40 to +85	°C

Table 3. ELECTRICAL OPERATING CHARACTERISTICS (Note 1)

Symbol	Parameter	Conditions	Min	Typ	Max	Units
$R_{I/O}$	Resistance		900	1000	1100	Ω
C	Capacitance per line	At 1 MHz, $V_{IN} = 0$ V	80	100	120	pF
V_{BR}	Breakdown voltage (Reverse)	$I_R = 1$ mA	6	8	10	V
I_{LEAK}	Leakage current at stand off voltage V_{RM}	$V_{RM} = 3$ V per line			500	nA
V_{ESD}	ESD Protection Peak Discharge Voltage a) Contact Discharge per IEC 61000-4-2 standard b) Air Discharge per IEC 61000-4-2 standard	(Note 2)	± 15			kV

- All parameters specified at $T_A = 25^\circ\text{C}$ unless otherwise noted.
- Standard IEC 61000-4-2 with $C_{Discharge} = 150$ pF, $R_{Discharge} = 330$ Ω .

CM6310

RF CHARACTERISTICS

$T_A = 25^\circ\text{C}$, DC bias = 0 V, 50 Ω Environment Using Evaluation PCB

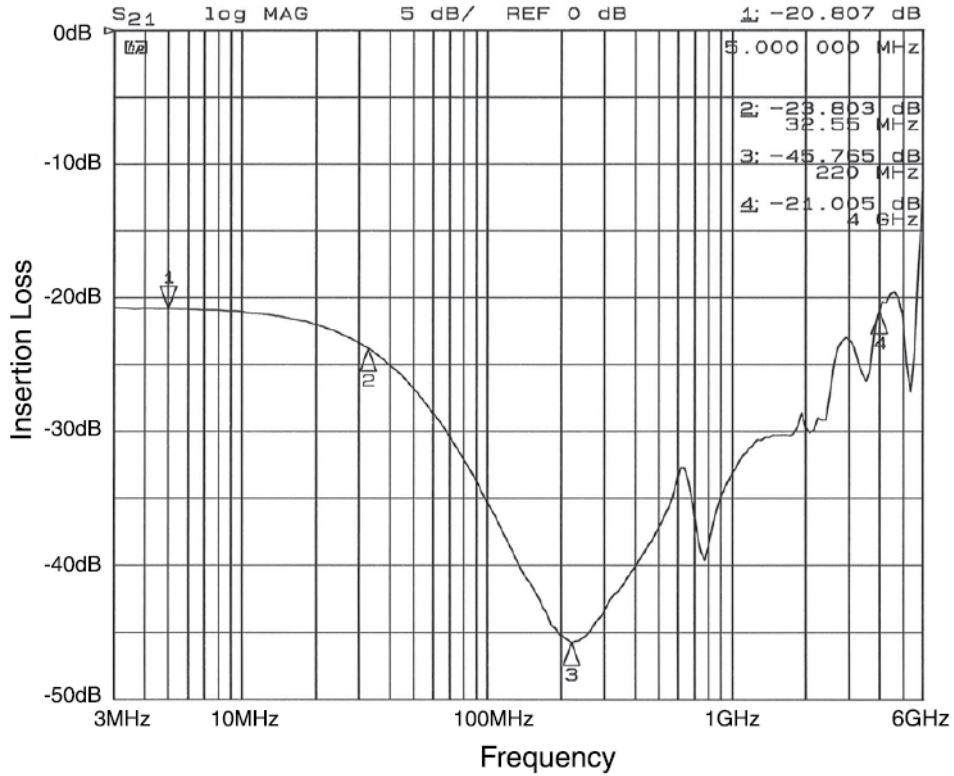

Figure 1. Typical Filter Frequency Response

MECHANICAL SPECIFICATION

Table 4. VERTICAL STRUCTURE DIMENSIONS (nominal)

Ref.	Parameter	Material	Dimension
a	Die Thickness	Silicon	406 μm
b	Bump Standoff		240 μm
d	UBM-(Ti/Cu)	Plated Cu	5.0 μm
		Sputtered Cu	0.4 μm
		Sputtered Ti	0.1 μm
e	UBM Wetting Area Diameter		280 μm
f	Solder Bump Diameter after Bump Reflow		320 μm
c	Metal Pad	AlSiCu	1.5 μm
g	Metal Pad Diameter		324 μm
D2			0.406 mm
D1	Finished Thickness		0.650 mm

Vertical Structure Specification*

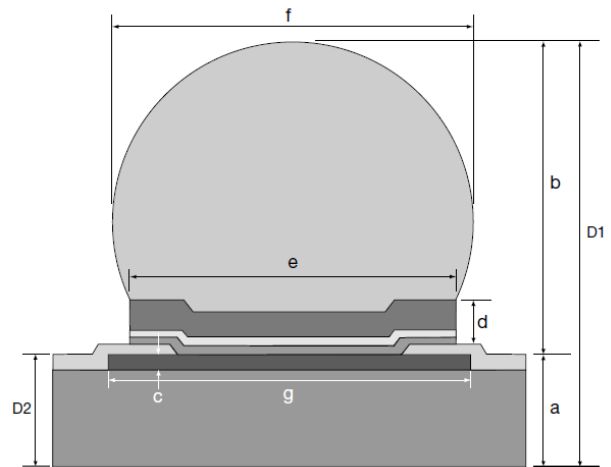

Figure 2. Sectional View

* Daisy Chain CM6010

CM6310

PACKAGE DIMENSIONS

WLCSP24, 2.6x2.6
CASE 567CJ-01
ISSUE 0

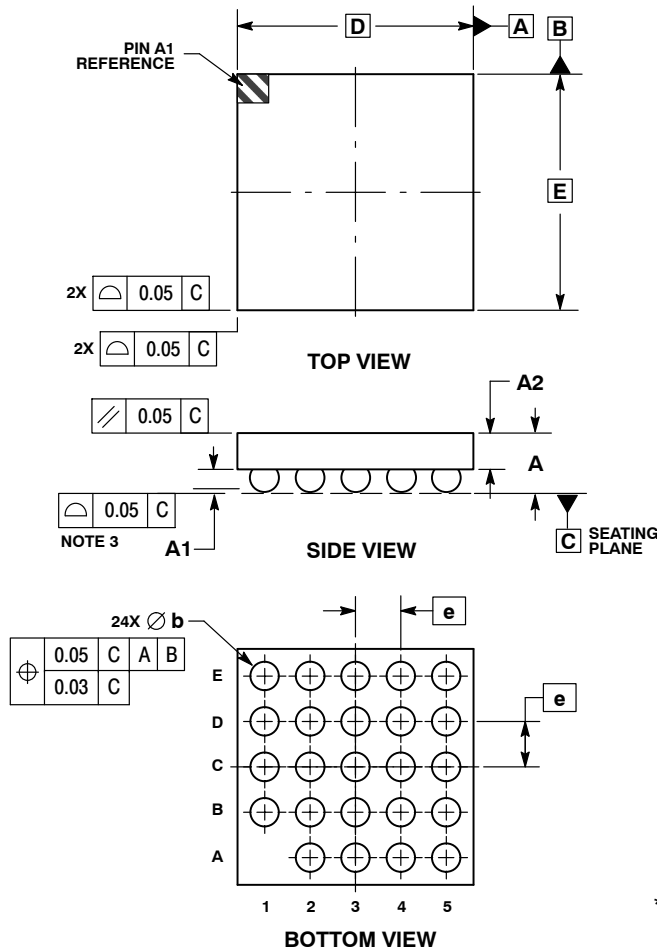

NOTES:

1. DIMENSIONING AND TOLERANCING PER ASME Y14.5M, 1994.
2. CONTROLLING DIMENSION: MILLIMETERS.
3. COPLANARITY APPLIES TO SPHERICAL CROWNS OF SOLDER BALLS.

DIM	MILLIMETERS	
	MIN	MAX
A	0.61	0.69
A1	0.21	0.27
A2	0.41 REF	
b	0.29	0.34
D	2.60 BSC	
E	2.60 BSC	
e	0.50 BSC	

RECOMMENDED SOLDERING FOOTPRINT*

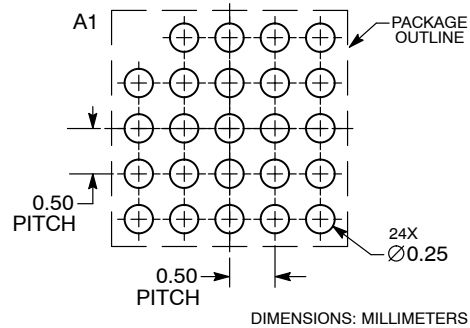

*For additional information on our Pb-Free strategy and soldering details, please download the ON Semiconductor Soldering and Mounting Techniques Reference Manual, SOLDERRM/D.

ON Semiconductor and are registered trademarks of Semiconductor Components Industries, LLC (SCILLC). SCILLC reserves the right to make changes without further notice to any products herein. SCILLC makes no warranty, representation or guarantee regarding the suitability of its products for any particular purpose, nor does SCILLC assume any liability arising out of the application or use of any product or circuit, and specifically disclaims any and all liability, including without limitation special, consequential or incidental damages. "Typical" parameters which may be provided in SCILLC data sheets and/or specifications can and do vary in different applications and actual performance may vary over time. All operating parameters, including "Typicals" must be validated for each customer application by customer's technical experts. SCILLC does not convey any license under its patent rights nor the rights of others. SCILLC products are not designed, intended, or authorized for use as components in systems intended for surgical implant into the body, or other applications intended to support or sustain life, or for any other application in which the failure of the SCILLC product could create a situation where personal injury or death may occur. Should Buyer purchase or use SCILLC products for any such unintended or unauthorized application, Buyer shall indemnify and hold SCILLC and its officers, employees, subsidiaries, affiliates, and distributors harmless against all claims, costs, damages, and expenses, and reasonable attorney fees arising out of, directly or indirectly, any claim of personal injury or death associated with such unintended or unauthorized use, even if such claim alleges that SCILLC was negligent regarding the design or manufacture of the part. SCILLC is an Equal Opportunity/Affirmative Action Employer. This literature is subject to all applicable copyright laws and is not for resale in any manner.

PUBLICATION ORDERING INFORMATION

LITERATURE FULFILLMENT:
Literature Distribution Center for ON Semiconductor
P.O. Box 5163, Denver, Colorado 80217 USA
Phone: 303-675-2175 or 800-344-3860 Toll Free USA/Canada
Fax: 303-675-2176 or 800-344-3867 Toll Free USA/Canada
Email: orderlit@onsemi.com

N. American Technical Support: 800-282-9855 Toll Free USA/Canada
Europe, Middle East and Africa Technical Support:
Phone: 421 33 790 2910
Japan Customer Focus Center
Phone: 81-3-5773-3850

ON Semiconductor Website: www.onsemi.com
Order Literature: <http://www.onsemi.com/orderlit>
For additional information, please contact your local Sales Representative